



CAMERA INSTRUCTION MANUAL

**NIMSLO**<sup>®</sup> 35mm  
**3D**

# CONGRATULATIONS

Welcome to the world of Nimslo 35mm 3-Dimensional photography. Now that you own a Nimslo 35mm 3-Dimensional Camera, you can take photographs that have depth and realism as well as excellent detail and beautifully rich and vibrant color.

You no longer look at photographs. You look into them.

This Instruction Manual will show you how simple 3-Dimensional photography can be. Please take a few minutes to read the instructions and some suggestions which are designed to help you obtain the best possible results from your revolutionary new camera.



## DESCRIPTION OF PARTS

1. Film Advance Lever
2. Shutter Release Button with Cable Release Socket
3. Dedicated Pin for Nimslo Opti-Lite Flash
4. Accessory Shoe with Automatic Flash Contact
5. Film Speed Selector
6. Exposure Meter
7. Viewfinder Window
8. Frameline Illumination Window
9. Film Rewind Crank
10. Film Rewind Knob/Back Cover Release
11. Optical Glass Lenses
12. Neck Strap Lug and Ring
13. Exposure Counter Window

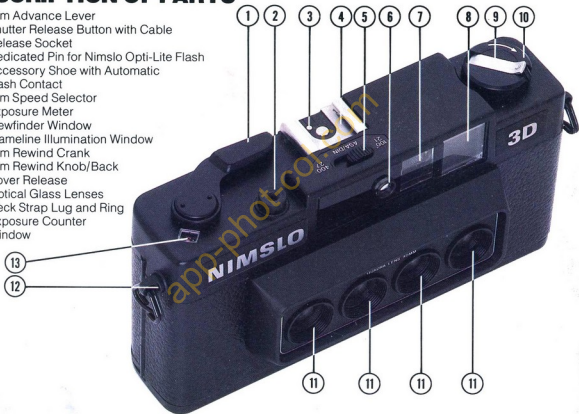

# TABLE OF CONTENTS

## Page No.

Description of Parts . . . . .	Front and Back Flaps
How to Use This Book . . . . .	1
Installing the Batteries . . . . .	2
Checking the Batteries . . . . .	3
Loading and Advancing The Film . . . . .	4, 5, 6, 7
Exposure Counter & Setting the Film Speed . . . . .	8
Holding The Camera . . . . .	9
Checking Light & Automatic Flash Photography . . . . .	10
Taking Pictures Automatically . . . . .	11, 12
Rewinding and Unloading Film . . . . .	13, 14
Care and Storage of Your Camera	
Photographs & Negatives . . . . .	15
3-Dimensional Picture Suggestions . . . . .	16, 17
Specifications . . . . .	18
Warranty . . . . .	19
Customer Service . . . . .	20

# HOW TO USE THIS BOOK

Open the front and back flaps of your Instruction Manual as shown. Refer to the numbers in the Description of Parts as you read through the instructions for a handy reference.



# INSTALLING THE BATTERIES

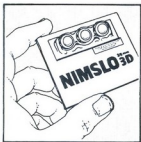

## 1. The batteries

Three Eveready 386 silver oxide batteries have been packed separately in your camera package.

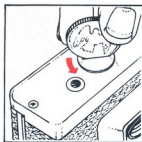

## 2. Opening the Battery Chamber

Insert a coin, or similar object, into the groove in the Battery Chamber Cover (23). Make a 1/3 turn, counter clockwise, and remove.

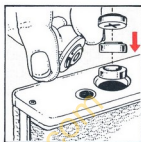

## 3. Battery Insertion Procedure

Insert the batteries one on top of the other into the Battery Chamber with the plus mark (+) facing into the camera.

You may find it more convenient to load the batteries by placing the flat plus (+) side of the battery against the bottom of the camera and slide it toward the opening of the Battery Chamber, as illustrated. Let each battery drop into the Battery Chamber until all three have been loaded. Return the Battery Chamber Cover and tighten.

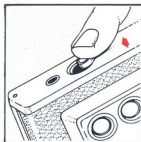

# CHECKING THE BATTERIES

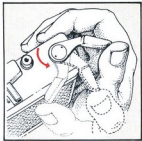

## 1. Advance the Film Advance Lever

Check the batteries each time before using the camera. Advance the Film Advance Lever (1) to cock the shutter.



## 2. Depress the Shutter Release Button

Then press the Shutter Release Button (2) lightly while looking into the Viewfinder Eyepiece (15).

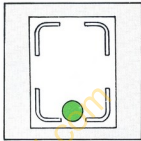

## 3. Green dot location in Viewfinder

If a green dot appears at the bottom or a red dot in the center of the viewfinder, the batteries have enough power to operate your camera.

If neither signal appears, the batteries are either positioned incorrectly or have insufficient power and must be replaced.

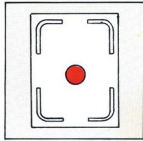

## 4. Red dot location in Viewfinder

# LOADING & ADVANCING THE FILM

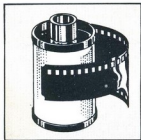

## 1. Uses 35mm color print film

Your Nimslo Camera uses all popular brands of 35mm color print film with a rating of either ASA 100 or 400. You may use any brand in 36, 24, 20 or 12-exposure rolls. However, AGFA film is sold with pre-paid processing mailers which cannot be redeemed by Nimslo.

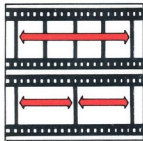

## 2. Two 35mm frames produce one 3-Dimensional photograph

The Nimslo 3-Dimensional process requires a group of four half-frame 35mm negative images to produce a 3-Dimensional photograph. Therefore, HALF THE NUMBER OF PICTURES STATED ON THE FILM CASSETTE WILL BE PRODUCED ON ANY ROLL OF FILM USED IN YOUR NIMSLO CAMERA.

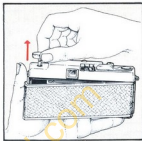

## 3. Opening the camera

Open the Camera Back Cover (19) by pulling up firmly on the Film Rewind Knob (10) as far as it will go until the back springs open.

Avoid direct sunlight when you load or unload the camera.

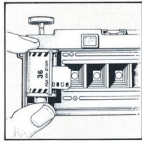

## 4. Place the film into the Film Chamber

Leave the Film Rewind Knob (10) in the up position and insert the film cassette with its lip pointed to the right and the protruding end down, into the Film Chamber (21).



## LOADING & ADVANCING THE FILM (CONT.)

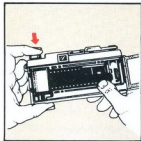

### 5. Secure the film cassette and bring film to the Take-Up Spool

Press the Film Rewind Knob (10) down as illustrated. You may have to rotate the Film Rewind Knob slightly for it to return to the down position.

Pull out just enough film to reach the Take-Up Spool (17).

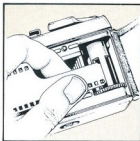

### 6. Film can be inserted into any slot of the Take-Up Spool

Insert the end of the film leader into a slot of the Take-Up Spool.

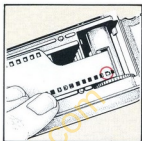

### 7. Attach your film to the Take-Up Spool

Latch one of the film perforation holes on the bottom edge of the film onto the small Film Perforation Hole Hook (26) at the base of the Take-Up Spool.



### 8. Tighten the film

Fold out the Film Rewind Crank (9) and gently turn it in the direction of the arrow to take up any slack in the film. (Be careful not to "over" rewind the film back into the cassette!) Fold back the Film Rewind Crank to its original position.

## LOADING & ADVANCING THE FILM (CONT.)

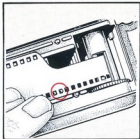

### 9. Engage the film on the Film Sprocket Gear

Make sure the film perforation holes on the lower edge of the film, latch (or "hook") onto, the Film Sprocket Gear (24) — located at the lower edge of the film leader to the left of the Take-Up Spool. (The film should not obscure your view of the sprocket gear teeth.)

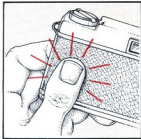

### 10. Close the Camera Back

Close the Camera Back Cover (19) by firmly pressing it into the locking position.

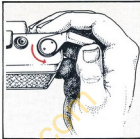

### 11. Advancing the film

Cock the Film Advance Lever (1) all the way... and release... allowing it to return to its normal position.

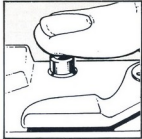

### 12. Releasing the Shutter

Press the Shutter Release Button (2).

## LOADING AND ADVANCING THE FILM (CONT.)

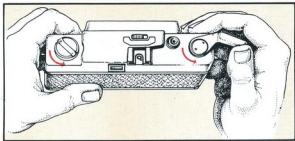

### 13. Confirm Film Advance

Note, that as you cock the Film Advance Lever (1), the Film Rewind Knob (10) rotates in a counter clockwise direction indicating that the film is advancing properly.

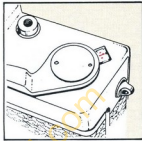

### 14. Advance to number 1 for your first picture

Repeat both steps until the number "1" appears in the center of the Exposure Counter Window (13). (You may have to repeat the sequence 1 or 2 times.)

# EXPOSURE COUNTER & SETTING THE FILM SPEED



## 1. Exposure Counter Window

The Exposure Counter Window (13) tells you how many pictures you have taken. Since your camera uses two "standard" exposures for every one 3-Dimensional picture, the counter will indicate a maximum of 18 pictures (for a roll of 36 exposures.) Always keep in mind that the number of 3-Dimensional exposures available equals  $\frac{1}{2}$  of the exposures stated on the film box – with the Exposure Counter automatically keeping track. To further remind you, the numbers 6, 12, and 18 are highlighted in red to indicate the end of the roll (for 12, 24, and 36 exposure rolls, respectively).

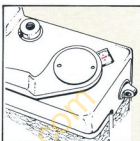
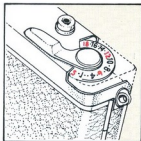

## 2. Numerical frame indication

Dots as well as numbers indicate the exposure count. You won't see consecutive numbers: 1 2 3 4 5 6 7 8. You will see: 1 • 4 • 6 • 8 and so on.)

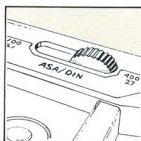

## 3. Setting film speed

Move the Film Speed Selector (5) on top of the camera toward ASA 100 or 400 to match the film you have loaded into your camera.

As a reminder, keep the end flap of your film box and place it in the sticker holder on your neck strap for quick reference of both your film speed and number of exposures.

# HOLDING THE CAMERA



## 1. CORRECT camera position

Hold the camera firmly at the sides with both hands and bring it to your eyes in a level position as shown above. Keep your fingers, and all other objects, away from the front of the lenses.



## 2. INCORRECT camera position

The four half-frame negatives needed to produce a Nimslo 3-Dimensional photograph must be aligned horizontally, so do not turn the camera incorrectly or hold it vertically, as shown above.

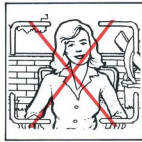

# CHECKING LIGHT & AUTOMATIC FLASH PHOTOGRAPHY

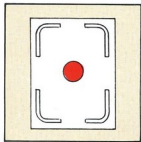

## 1. Red Signal

Look into the Viewfinder Eyepiece (15), and push down lightly on the Shutter Release Button (2), being careful not to depress the button all the way down for an exposure. When the button is partially depressed, you see either a red or green dot. The Film Advance Lever (1) must be cocked.

A red dot indicates there is not enough light available for a correctly exposed negative and that an Opti-Lite Flash should be used for additional lighting. Once the flash is attached—and turned on—a green dot will soon appear in the viewfinder indicating the flash is ready.

A green dot indicates there is sufficient light available for a correctly exposed picture. When using your Nimslo Opti-Lite Electronic Flash, the green dot also serves as a "flash ready" signal.

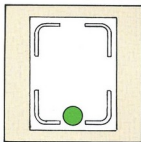

## 2. Green signal

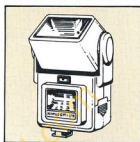

## 3. Nimslo Opti-Lite Electronic Flash

For most indoor and evening photos, it is advisable to use the Nimslo Opti-Lite Electronic Flash to provide the proper illumination or eliminate unwanted shadows.

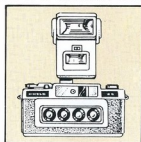

## 4. The Nimslo 35mm 3-Dimensional Camera and Opti-Lite Electronic Flash

The Nimslo Opti-Lite Electronic Flash has been exclusively designed for the Nimslo 35mm 3-Dimensional Camera. It possesses a unique twin flash for both direct and "bounce" lighting to enhance all objects that add to the depth of the picture.

# TAKING PICTURES AUTOMATICALLY

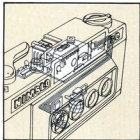

## 1. Taking pictures automatically

Sophisticated electronic circuitry built into the camera automatically controls the exposure allowing you to concentrate only on framing and composition. Your camera will automatically select the best combination of aperture and shutter speed to achieve a correctly exposed negative.



## 2. Framing the picture

Looking into the Viewfinder Eyepiece (15) you'll see a bright line frame—an outline of the image area in which you can compose your photograph quickly and accurately. It is a guide to show you which objects in the scene will actually be in your 3-Dimensional photograph.

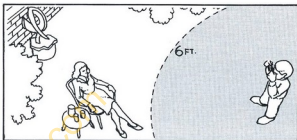

## 3. Viewing a typical 3-Dimensional scene

For best 3-Dimensional results, make sure the subject is at least 6 feet from your camera. Be careful to keep the area in front of your photographic subject clear and uncluttered.

## TAKING PICTURES AUTOMATICALLY (CONT.)



### 4. Now you and the camera are ready to take pictures

Because the lenses are prefocused, no manual adjustments are required. Simply hold the camera steady and press gently down on the Shutter Release Button (2) until you hear a click.



### 5. Advance the Film

Before you take the next picture, advance by moving the Film Advance Lever (1) one full stroke (and letting it return to its original position.) Now you are ready to shoot again.

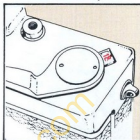

### 6. End of Roll

When all the exposures are used, you will see a red number in the Exposure Counter Window (13) and *feel a resistance* indicating the end of the roll. **DO NOT FORCE THE FILM ADVANCE LEVER** at this point. It's time to re-wind and unload the film.



# REWINDING AND UNLOADING FILM

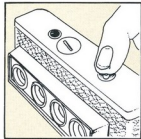

## 1. Film Rewind Release Button

To disengage your film when it is complete, depress the Film Rewind Release Button (25) on the bottom of the camera.

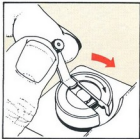

## 2. Film Rewind Crank

Fold out the Film Rewind Crank (9) on top of the camera. Turn the crank in the direction of the arrow (clockwise) to rewind the film back into the cassette. You will feel tension while rewinding. Continue to turn the Film Rewind Crank until you feel no tension indicating that the film has been fully rewound.

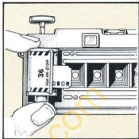

## 3. Unloading the Film

Pull up the Film Rewind Knob (10) to open the back of the camera and remove the film cassette.

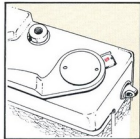

## 4. Exposure Counter

The Exposure Counter (13) automatically will return to "S" when the Camera Back Cover is opened.

# REWINDING AND UNLOADING FILM (CONT.)

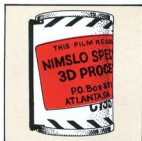
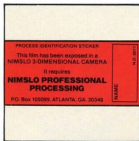

## 5. Film Process Identification Sticker

One of the red stickers supplied in the package with your camera purchase *must be placed on* your film cassette to alert the store clerk where you take your film for processing that SPECIAL NIMSLO HANDLING is required to obtain 3-Dimensional pictures. Please write your last name in the box provided on the film process identification sticker, as an additional means of identification. A new supply of Process Identification Stickers will be returned to you with each finished roll of Nimslo processed pictures. They are also available at all authorized Nimslo Professional Processing outlets.

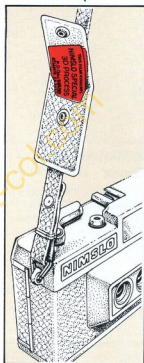

## 6. Sticker Holder on Camera Neck Strap

Place a supply of Film Process Identification Stickers in the Sticker Holder on your camera neck strap for handy use after completing a roll of film.

# CARE AND STORAGE OF YOUR CAMERA, PHOTOGRAPHS & NEGATIVES

## Camera

Do not drop the camera, knock it against anything solid or misuse it. Accidents and rough handling can easily damage the internal mechanism of the Camera.

Your camera is *not* waterproof. Protect it from water splashes and rain.

Do not touch the lenses.

Always keep the viewfinder and lenses as clean as possible. To remove loose dust and dirt, clean with a lens brush or soft lint-free cotton cloth. Do not try to wipe off granular dirt or dust by any other means or you may scratch the lenses.

Smudges, such as finger prints, should be carefully wiped away with a lens cleaning tissue. For difficult marks, use a liquid lens cleaner and lens tissue.

When storing your camera, keep it in a cool, dry, clean, well-ventilated place.

If storing for a long period, the batteries should be removed from the battery chamber.

Do not leave your camera in the glove compartment or rear window deck of your car.

## Photographs

Nimslo photographs are made on a special material which is highly durable and resistant to extreme temperatures. However, you should treat Nimslo 3-Dimensional photographs like any other photo sensitized product and be careful to protect the surface from scratches and liquids which may leave a mark or smudge on the material.

## Negatives

A lint free wallet will be supplied with your developed negatives for safe storage. Please remember always to **HANDLE DEVELOPED NEGATIVE STRIPS BY THE EDGES**. Oil from your skin and other substances from your fingers usually ruin otherwise perfect negatives.

When you require reprinted copies of your 3-Dimensional prints you must supply the original negative groups in strips to your Nimslo Dealer or your Nimslo Professional Film Processing Laboratory.

**IMPORTANT** a copy print cannot be made from your Nimslo 3-Dimensional Print, the laboratory must have the original negative group.

## 3-DIMENSIONAL PICTURE SUGGESTIONS

- The world around you is three-dimensional and it is usually best to take pictures of subjects and objects just the way they are naturally.
- Look at the picture on the right. Scale and depth in the picture are provided by the relationship of each object to the others, as well as the *height*, *width* and *depth* of objects. A variety of items in the picture will enhance the 3-Dimensional effect. Bright colorful areas in pictures also add depth. You can achieve this by having your subject wear colorful clothes or by taking pictures of colorful scenes.
- Frame your picture to include subject and background objects.
- For scenic pictures, include perhaps a tree, a person, etc., so that your picture has foreground interest as well as background and scenery. **REMEMBER, KEY PICTURE SUBJECTS MUST BE AT LEAST 6 FEET FROM THE CAMERA FOR BEST RESULTS.**
- For best results outdoors, try to keep the sun over your shoulder while avoiding poses that have your subject facing directly into the sun.
- Posing subjects directly against a wall, will result in flat pictures lacking depth. Move the subject to a more interesting area — one with greater perspective — with more space between the subject and background.
- Pictures of scenes beyond 25 feet will not appear to have as much depth as you might anticipate. In this picture taking situation, position a subject or object at least 6 feet from your camera and use the setting beyond 25 feet as your background.

app-phot-000000

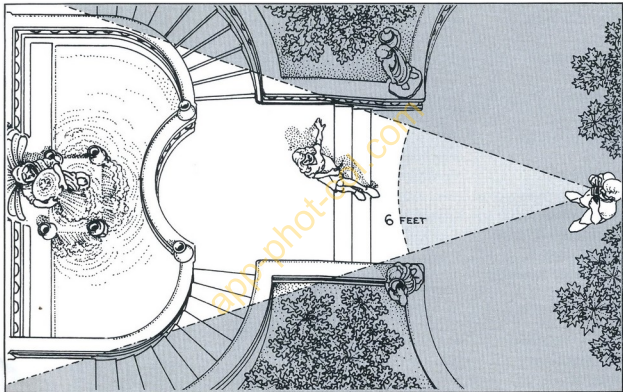

# SPECIFICATIONS

<b>Camera Type:</b>	35mm, Automatic 3-Dimensional
<b>Film Size/Type:</b>	35mm Color Print ONLY
<b>Film Speeds:</b>	ASA 100/DIN 21 ASA 400/DIN 27
<b>Shutter:</b>	Automatic, Electronically Programmed Speeds from 1/30 to 1/500 Second
<b>Lenses:</b>	Quadra Lens System: Four 30mm, f/5.6, Air Spaced Triplets, with Coated, High-Index, Optical Glass Elements Pre-focused 6' (2m) to infinity
<b>Flash</b>	
<b>Synchronization:</b>	Dedicated Hot Shoe Contact for Cordless Flash Connection to Nimslo Opti-Lite Electronic Flash (Other Types of Flash Units May Be Used)
<b>Viewfinder:</b>	Bright Frame, Vertical Format
<b>Information:</b>	Green LED sufficient light and battery OK condition; Red LED low light warning.
<b>Film Advance:</b>	Single-Stroke Film Advance Lever
<b>Exposure Counter:</b>	Automatic Reset
<b>Film Rewind:</b>	Rewind Crank lifts clear from body
<b>Exposure Control:</b>	CdS Cell measures light to program shutter speed and aperture size for best combination to achieve correctly exposed negatives
<b>Power Source:</b>	Three (3) No. 386 Eveready or Duracell, Silver Oxide Batteries. Equivalent batteries are: Maxell SR 43W, Panasonic WL11 and Ray-O-Vac RW24/44
<b>Other Features:</b>	Built-in Double Exposure Prevention
<b>Dimensions:</b>	5 $\frac{3}{8}$ " x 2 $\frac{7}{8}$ " x 1 $\frac{5}{8}$ "
<b>Weight:</b>	12 ounces

# WARRANTY

Your Nimslo camera is warranted against defects in workmanship and materials for a period of one year from the date of purchase. Please retain your dated sales slip or other proof of the purchase date to validate the warranty period. Without this information, the warranty period will be determined from the manufacturing date of the camera.

If your camera proves to be defective within the warranty period, we will repair or at our option, replace it with a fully reconditioned camera at no charge to you. The repaired or replaced unit will carry the remaining portion of the warranty period applicable to the original camera.

To obtain warranty service, the camera must be returned to or repaired by a Nimslo Service Center or a Nimslo Authorized Service Center. You may also return the camera

through your Nimslo Dealer. If that is inconvenient for you or if you have any other questions at all, please contact your Nimslo Customer Service Representative toll free at 1-800-554-2854 from anywhere in the continental United States. In Georgia, please call 1-800-282-8988.

**THIS WARRANTY DOES NOT COVER DAMAGE CAUSED BY ACCIDENT, MISUSE OR TAMPERING WITH THE CAMERA, NOR DOES IT ALLOW FOR CONSEQUENTIAL DAMAGES. (SOME STATES DO NOT ALLOW THE EXCLUSION OR LIMITATION OF INCIDENTAL OR CONSEQUENTIAL DAMAGES, THEREFORE, THE FOREGOING LIMITATION MAY NOT APPLY TO YOU.)**

This warranty gives you specific legal rights and you may also have other rights which may vary from state to state.

app-photos.com

## **CUSTOMER SERVICE**

Your satisfaction with your Nimslo 35mm 3-Dimensional Camera and pictures is important to us. If you have any questions or problems, please call our toll free number ...1-800-554-2854 (1-800-282-8988) in Georgia). Our Customer Service Department is open each weekday from 8:30 a.m. to 4:30 p.m. Eastern Standard Time to answer your questions and to help you enjoy your Nimslo camera.

### **Corporate Office**

Nimslo Corporation  
One Nimslo Park  
Atlanta, Georgia 30338

### **Branch Office**

Nimslo Corporation  
76 Watertown Road  
Thomaston, Connecticut 06787

### **Branch Office**

Atlanta Regional Processing Center  
3500 McCall Place  
Atlanta, Georgia 30340

app-phot-ces.com



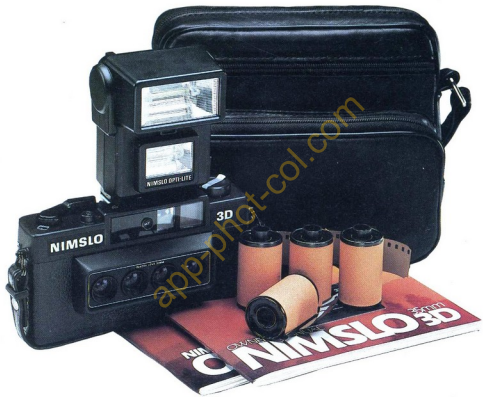

## DESCRIPTION OF PARTS (CONT.)

- 14. Film Guide Pins
- 15. Viewfinder Eyepiece
- 16. Film Guide Rails
- 17. Film Take-up Spool
- 18. Film Pressure Plate
- 19. Camera Back Cover
- 20. Film Rewind Fork
- 21. Film Chamber
- 22. Tripod Socket
- 23. Battery Chamber Cover
- 24. Film Sprocket Gear
- 25. Film Rewind Release Button
- 26. Film Perforation Hole Hook

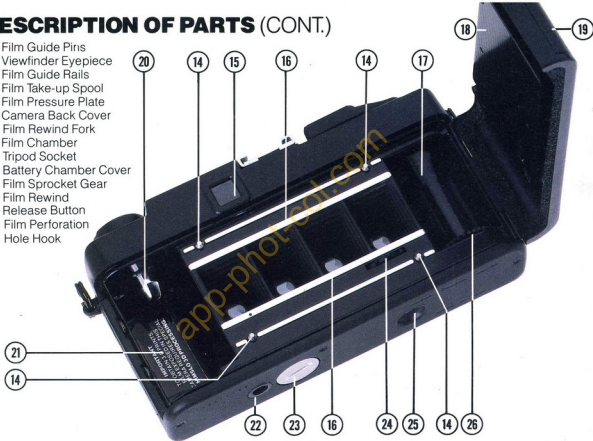



app-phot-col.com

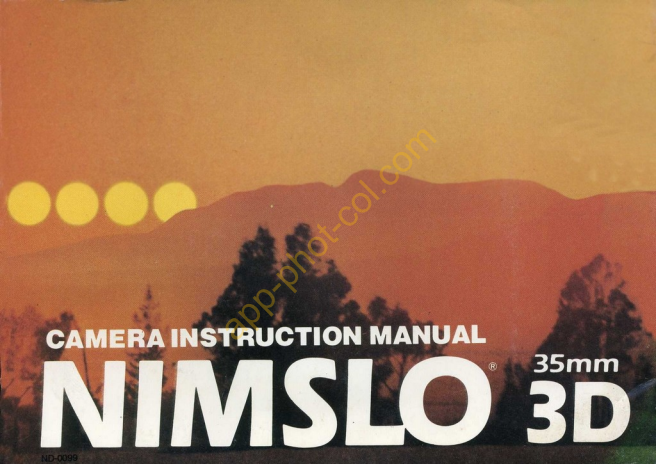

**CAMERA INSTRUCTION MANUAL**

**NIMSLO<sup>®</sup> 35mm**  
**3D**