

Mamiya

M645 SUPER

Instructions

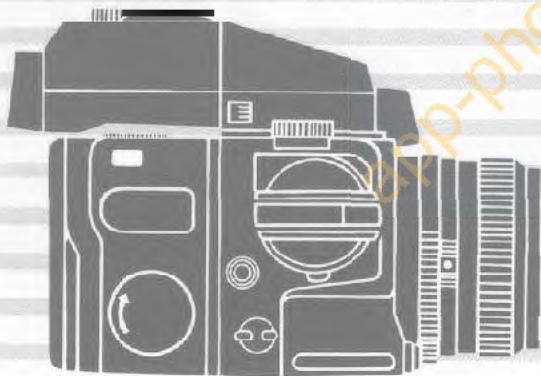

Thank you very much for your purchase of the M645 Super.

The Mamiya M645 Super is the latest 6 x 4.5cm medium format SLR. This camera has been developed through Mamiya's expertise in the most advanced technologies and offers the quality of a large negative as well as the maneuverability and operating convenience normally found only in smaller cameras.

In order to satisfy the demands of the professional photographer there is a broad assortment of accessories available the AE Prism Finder and its 3-way metering system, automatic Power Drive and a Polaroid® film back are representative samples of the M645 system accessories that make it possible to further expand the scope of your photography.

You can combine various types of system accessories to suit your applications, and enjoy your photography.

For instructions of other system accessories, please refer to the respective instructions supplied with these items.

To ensure proper operation of your M645 Super, please be sure to read this Manual carefully before using your camera.



Special Features of Mamiya M645 Super	2	Aperture Ring/Stop-down Operation	20
Names and Function of Parts	5	Shutter Release Operation	21
Attaching and Removing Lenses	8	Methods of Holding the Camera Securely	22
Attaching and Removing Roll Film Holders	9	Film Transport and Film Unloading	23
Attaching and Removing Finders	10	Depth-of-field	24
Attaching and Removing the Wind-up Crank	11	Using Flash	26
Inserting Battery and Battery Check	12	Multiple Exposures/Infrared Photography	27
Operation Test	13	Time Exposures/Mirror Lock-up Photography	28
Film Loading	14	Using a Tripod/Using Delayed Shutter Release	29
Advancing Film to the First Exposure	17	Handling Precautions	30
Shutter Speed Dial	18	Storing and Checking the Camera	31
Focusing	19	Specifications	32

SPECIAL FEATURES OF MAMIYA M645 SUPER:

1 3 Times More Area than 35mm Format, Less Waste of The Negative Area:

The 6 x 4.5cm format offers approx. 3 times more area than the 35mm (24 x 36mm) format. The horizontal and vertical ratio of the area is proportional to the size of most printing papers, so there is little waste of the negative area. For beautiful color enlargements, the 6 x 4.5cm is the ideal format.

2 Versatile, Light-Weight Body:

The M645 Super is a compact, light-weight, all-round camera designed to handle as easily and speedily as a 35mm SLR.

Its size and weight are well suited for action photographers.

3 Interchangeable Film Holder System Enables Polaroid Photography:

The M645 Super features an interchangeable film holder system. A range of film holders can be used depending on the application. A 35mm Roll Film Holder, "Polaroid" Land Pack Film Holder as well as 120 and 220 Roll Film Holders are available. This system can be quickly attached to the

camera, ready for the first photograph. Also, fail-safe devices are incorporated including a release lock and removal lock, using a Dark Slide.

4 Unique Moving Coil Electromagnetic Release and High-Precision Electronic Shutter:

The M645 Super features a revolutionary, quartz-controlled moving coil electronic shutter which conserves battery consumption.

The moving coil is operated twice by an electronic circuit, to actuate the electromagnetic release.

This unique method allows high-precision shutter control as well as wireless remote control.

5 Large, Bright Focusing Screen N, to satisfy your Applications:

It becomes easy to obtain optimum results when looking through the large, bright viewfinder. Five types of Focusing Screens are available to facilitate photographing special subjects.

6

Interchangeable Viewfinders for All Applications:

- **Lightweight, Waist Level Finder N**

The waist level finder hood can be opened and closed with a single action. Lifting the magnifier upright completely seals the hood, making the viewfinder ideal for outdoor photography, close-ups and copying. The sports finder which is located outside the hood is convenient for fast action photography.

- **Prism Finder N suitable for snap photography**

The prism finder is well-suited for action photography providing an unreversed, eye-level image. Horizontal or vertical photographs are both easy with this finder.

- **3-way TTL metering AE Prism Finder N**

This AE Prism Finder N features 3-way metering which can automatically switch from center-weighted averaging metering for general photography, to spot metering which will emphasize a specific photographic point or you can designate either of these metering methods according to photographic conditions. These metering systems facilitate AE Photography under difficult conditions, such as adverse lighting. Further a ± 3 EV exposure compensator expands the range of exposure control.

7

A wide Variety of Multi-coated Lenses for Clear, Sharp Images:

Mamiya-Sekor lenses have achieved world-renown recognition as professional lenses of exceptional contrast, high resolution, clear definition and excellent color balance. The lens series includes wide-angle to telephoto, and special applications lenses. All of these lenses are multi-coated to eliminate flare and ghosting, even under adverse lighting conditions.

8

A Broad Accessory System to Expand Your Scope:

A full range of accessories are available for the M645 Super to assist you in capturing virtually any type of image. These accessories include hand grips for convenient, easy handling, auto extension rings for easy close-ups and copying, auto bellows, and infrared cordless remote control to satisfy all photographic requirements. Please refer to the M645 Super system chart for a complete listing.

9

Others:

- **Hot-shoe**

Hot shoe type electronic flashes can be mounted.

- **Multiple exposure operation**

A simple operation of the Multiple Exposure. Lever allows you to take as many multiple exposures as you wish, thereby making it possible to explore new photographic situations.

- **Mirror lock-up system**

The mirror lock-up feature enables manual raising of the mirror before the exposure is made to minimize vibration. This provision makes clear close-up and telephoto photography possible even at slow shutter speeds.

app-phot-col.com

NAMES AND FUNCTIONS OF PARTS

Focusing Screen N

Aperture Ring Coupling Pin

This pin is fitted into the Exposure Meter Coupler of the lens, to transmit the aperture data to the AE Prism Finder.

Alignment Dot/Battery Check Lamp

Shutter Release Selector

A white square is used during normal photography. When a red dot is indicated, the shutter is locked, turning power OFF. When the battery is exhausted, the mechanical shutter can be released at approx. 1/60 second when this selector is aligned with the yellow dot.

Shutter Release Button

Focusing Screen Release Pin

When you want to change the screen, slide this pin to the left and remove the screen.

Mirror

*Never touch the surface of the mirror.

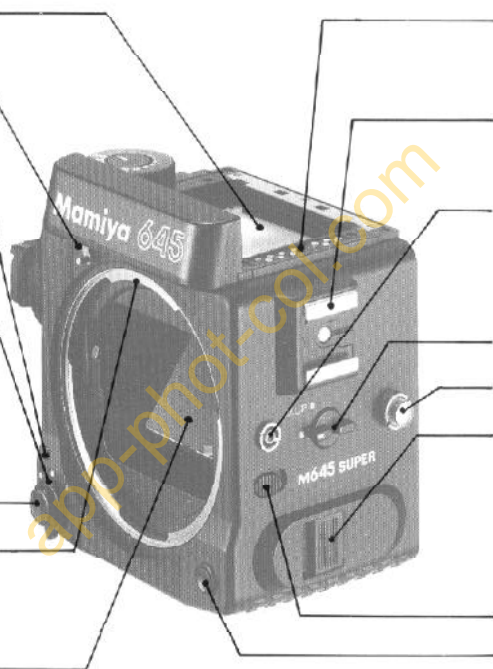

Viewfinder Contact

This electric contact is used to exchange data with AE Prism Finder.

Hot-shoe (X contact)

A cordless flash can be used with this shoe.

Flash Sync Terminal

A flash bulb, flash synchro card and optional synchro terminal adapter can be connected with this terminal.

Mirror Lock-up Lever

Neck Strap Lug

Auxiliary Release Contact

When the cover is moved to the left the contact appears. This contact is used for connections of external releases such as a special hand grip and remote control unit.

Lens Release Button

Battery Check Button

LED displays the present battery condition.

Finder Coupling Panel (Front)

Finder Coupling Panel (Rear)

Electric Contact for Film Holder

This contact receives film sensitivity data from the film holder.

Film Holder Mount

Shutter Curtain

Exposures are controlled by opening and closing the curtain. *Never touch the surface of this curtain.

Film Holder Coupling Pin Guide

Film Transport Gear

Film Holder Mounting Bracket

Shutter Speed Dial

This dial selects the shutter speed and switches the operation mode from manual to AE photography.

Shutter Speed Dial Lock Release Button

This button is used for unlocking the shutter speed dial from an AE position.

Wind-up Crank

A single complete turn cocks the shutter and advances the film for each exposure.

Wind-up Crank Lock Lever

Neck Strap Lug

Multiple Exposure Lever

When this lever is set at "MULTI", film is not advanced even when the Wind-up Crank is turned, thus allowing multiple exposures on the same film frame.

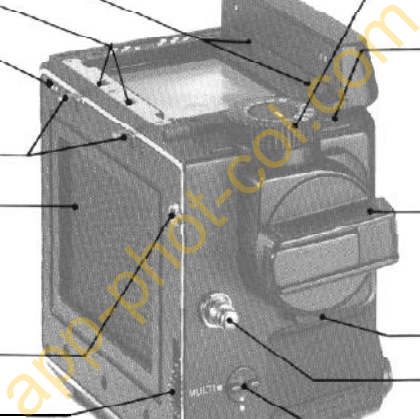

Focusing Ring

This ring adjusts the focus.

A.M. Lever

When you wish to check the effect of the aperture setting on the lens, set this lever to "MANUAL" and you can observe the effect through the viewfinder.

*Normally use your camera in "AUTO" position including AE photography.

Distance Scale

The camera to subject distance can be set or confirmed with this scale.

Depth-of-field Scale

Provides a quick reading of depth-of-field for various apertures and distances.

Lens Alignment Dot

Exposure Meter Coupler

This coupler is engaged with the Aperture Ring Coupling Pin, transmitting an f/stop number to the AE Prism Finder.

Tripod Socket

1/4" tripod socket. To convert to a 3/8" socket, remove the small screw in the base of the socket. Then remove the inner socket by turning counterclockwise with a coin.

Battery Chamber Cover

Battery Chamber Cover Latch

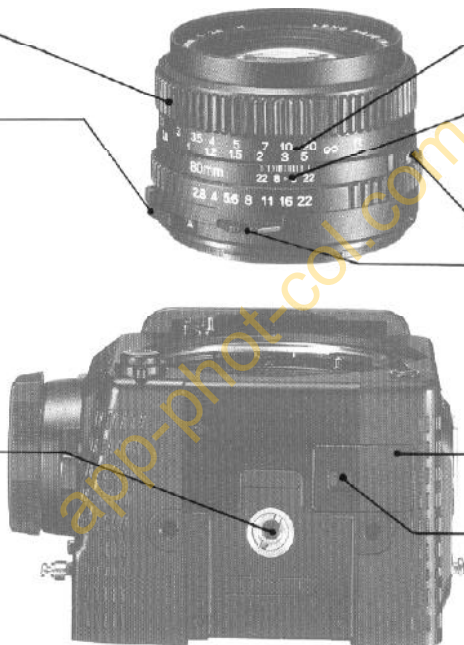

ATTACHING AND REMOVING LENSES

Removing the Front Body Cap:

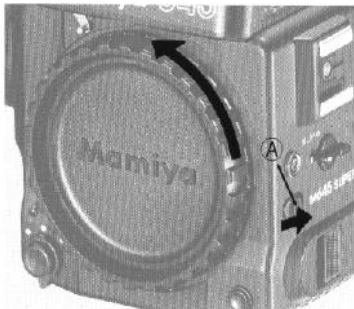

Turn the Front Body Cap in the direction of the arrow, while pushing the Lens Release Button (A) toward the arrow.

*The Upper and Rear Body Protective Covers can be readily removed.

Attaching the Lens:

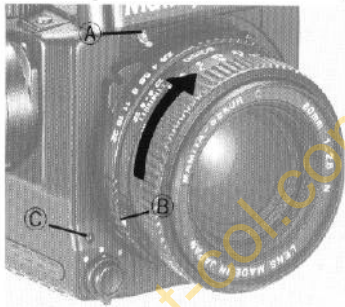

Align Lens Alignment Dot (B) with the Camera Alignment Dot (C). Insert the lens into the camera body. Then turn the lens in the direction of the arrow until it clicks and locks into place. Make sure that Aperture Ring Coupling Pin (A) is engaged with the Exposure Meter Coupler.

Removing the Lens:

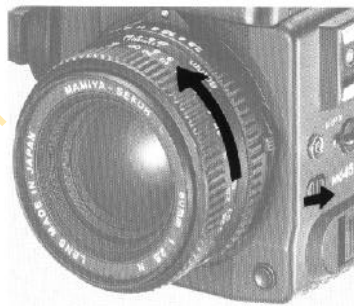

Remove the lens using the same procedure as described for the Front Body Cap.

ATTACHING AND REMOVING ROLL FILM HOLDERS

Attaching the Roll Film Holder:

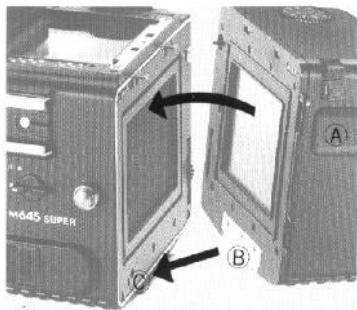

While holding the Rubberized Finger Rest (A) on both sides of the holder, position the Bottom Coupler of the holder (B) properly to the Holder Mounting Bracket (C) of the body. Press the upper part of the holder together with the body until clicks.

Removing the Roll Film Holder:

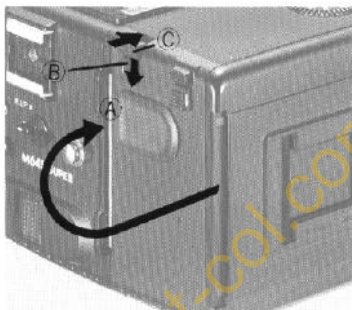

Insert the Dark Side between both white lines (A). To remove the holder, push the Button (C) away from the camera body while pressing down on the Lock Release Button (B).

The green line on the Dark Slide indicates the position to which the Dark Slide can be inserted into the Roll Film Holder without blocking the image.

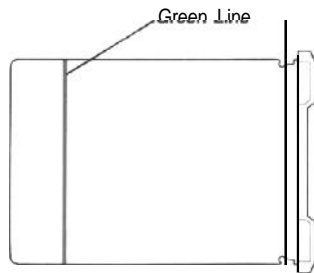

ATTACHING AND REMOVING FINDERS

Attaching the Finder

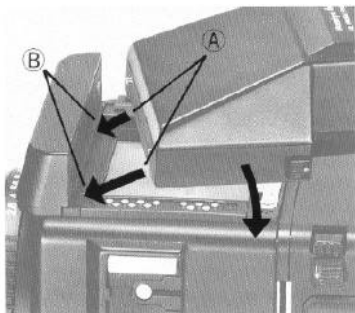

Insert the front finder mounting latch (A) into the body side slot (B) as shown by the arrows, and press the finder down until the rear hooks latch firmly.

Removing the Finder:



Hold the Finder Lock Release Button (●) in while pushing down on the Button (↓) on the opposite side of the finder.

*Other finders can be attached and removed in the same procedure as described above.

ATTACHING AND REMOVING THE WIND-UP CRANK

Removing the Crank:

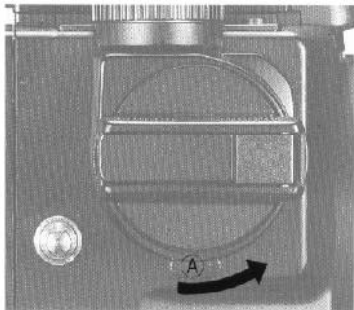

Push the Wind-up Crank Lock Lever (A) in the direction of the arrow, pull out the crank to remove.

Attaching the Crank:

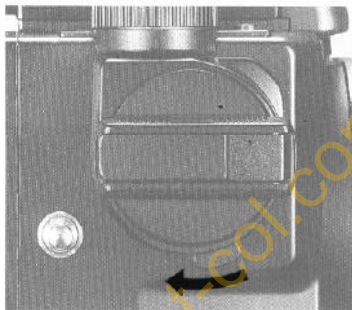

Pull the Lock Lever (A) in the direction of the arrow while pressing the crank against the camera body.

It is possible to select the start position of the Wind-up Crank in six different positions. The following figure shows the six different positions.

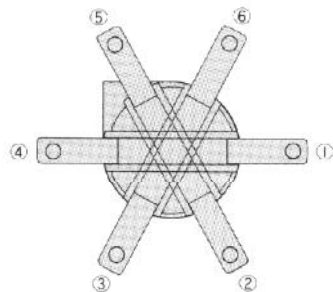

*For attaching and removing the Power Drive N, refer to its instruction manual.

INSERTING BATTERY AND BATTERY CHECK

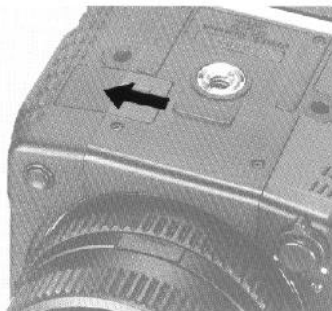

The M645 Super uses one 6V silver-oxide battery (4SR44) or 6V alkaline-manganese battery (4LR44). Pull the Battery Chamber Cover Latch (at the bottom of the camera body) in the direction of the arrow, and the Chamber Cover can be removed.



First, insert the battery \ominus terminal into the Battery Chamber and press the battery's \oplus terminal in while confirming battery polarity. Then close the cover. *Before inserting the battery, arrange the battery removal ribbon correctly passing it under, then over, the battery. Consequently the battery can be removed easily by pulling the end of the ribbon.

Battery Check

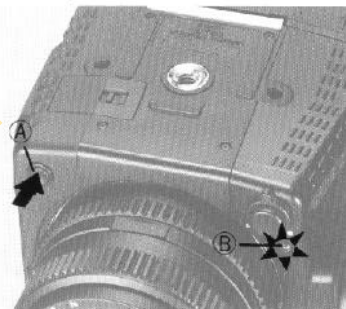

When the Battery Check Button **A** (located on the front of the camera) is depressed, the Battery Check Lamp **B** lights up. The lamp will not light if the battery capacity is insufficient or if the battery is inserted incorrectly.

Caution:

1. Carefully wipe the contacts of the battery before inserting it into the chamber. Failure to do this could result in poor electrical contact and consequent erratic functioning of the camera.
2. When the camera is not used for a long period of time, remove the battery and store it in a cool, dry place.
3. Battery life differs, depending on battery brand, period after manufacture, storage conditions, temperature during operation and operating frequency. Prior to use, check the battery condition, using a battery checker. It is recommended that you take a spare battery with you when going out on a photographic trip, for example.
4. This camera is designed for use with either a silver-oxide or alkaline-manganese battery. However, the life of a silver-oxide battery will be much longer. The silver-oxide battery is preferred when the AE Prism Finder is attached.

At times it may be necessary to rotate the film advance crank two full turns to cock the shutter when an empty take-up spool (without its original vinyl tube) is in the camera.

Operation Test



① Remove the Dark Slide

Pull out the Dark slide and place it into the Dark Slide Storage Slot.



③ Turn the Wind-up Crank

Advance the Wind-up Crank one complete revolution.



② Set the Lever to "MULTI,"

Set the Multiple Exposure Lever to the "MULTI □" mark position.



④ Release the Shutter

Set the Shutter Release Selector to the "□" mark, and press the button.

- ★ When only the body unit is tested, it is unnecessary to set the Multiple Exposure Lever to the "MULTI □" mark.
- ★ No Roll Film Insert is inserted into the Roll Film Holder.
- ★ Upon completion of the operation test, be sure to return the Multiple Exposure Lever to the "□" mark.

Loading the Film

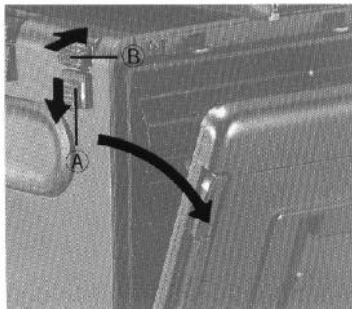

While pushing the Back Cover Lock Release Button (A) downward, press the Back Cover Opening Button (B), and the Back Cover will open.

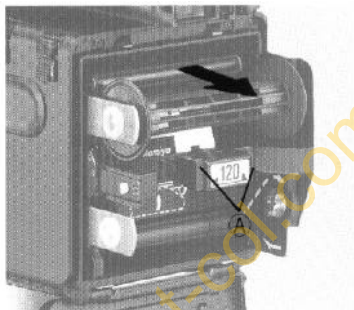

While squeezing in on both sides of the Release Latch (A), pull the Roll Film Insert out of the camera body. At that time, move the empty spool in the upper part down to the lower spool compartment.

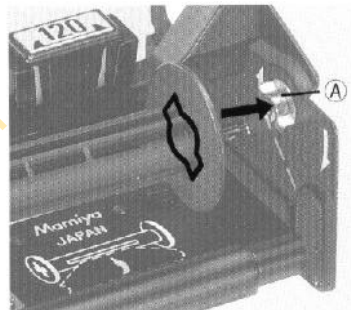

Align the right-hand side of this empty spool with the lower Spool Stud (A) (convex). Slide the spool into position making sure that the left-side of the spool is properly held by the Spool Clip.

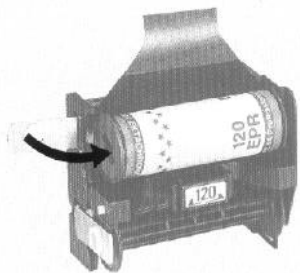

In the same manner, insert a roll of film in the upper compartment. At that time, check that the film leader paper is set as shown in the photo above. (The leader paper inside is facing outward on the pressure plate. Note that the film direction is wrong if the leader paper is facing inward.)



Pull out some of the leader paper. Insert the tip of the leader paper into the slot of the lower Take-up Spool.

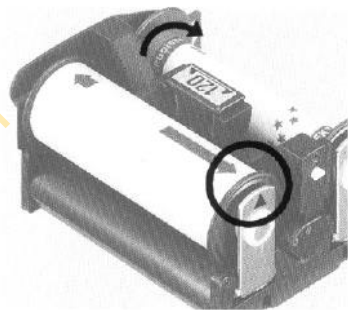
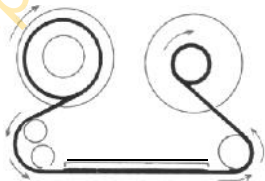

Gently rotate the Take-up Spool in the direction of the arrow until the start mark of the leader paper is aligned with the start mark (A) on the Spool Clip. (Correctly align the start marks with each other, taking care that the film is not rolled excessively.)

Insertion of the Roll Film Insert

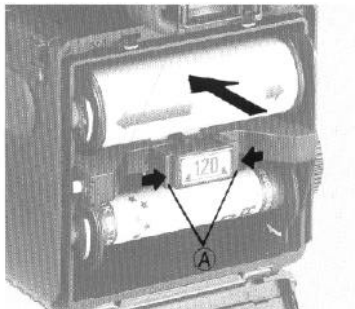

Insert the loaded Roll Film Insert straight into the holder as shown in the photo above. Be sure to check that the Roll Film Insert has been completely set before closing the Back Cover.

Memo Clip



The Memo Clip on the Back Cover is used to hold the box top of the film in use or a piece of paper for storing necessary data.

ADVANCING FILM TO THE FIRST FRAME

There are two methods for advancing film to the first frame.

In either case, when loading the film, always align the film with its start mark.



Film Advancing after the Roll Film Holder is mounted onto the Body:

Make sure that the Multiple Exposure Lever (A) is aligned with a white square dot. Wind the Wind-up Crank until it stops and the number 1 will appear in the Film Counter Window.

The shutter is now cocked and the camera is ready for the first exposure.



Film Advancing by Film Advance Knob of the Roll Film Holder

Check that the Dark Slide is completely inserted (light blocked). When the Film Advance Knob (A) of the Roll Film Holder is rotated in the direction of the arrow until it stops, the camera will be ready for the first exposure.

*It should be noted that when the Coupling Pin (refer to the manual for the Roll Film Holder) is depressed with the finger, the film will not stop at the first frame.

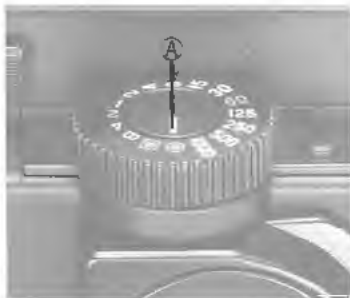

Align your desired shutter speed with the white alignment index (A).

*In other than the ● and ■ marks, the dial will rotate freely, and each shutter speed display will stop at the click point.

● Color Coding

- 1 The yellow 4 and 2 represent full seconds, and all other figures represent the denominator of a fraction. (Thus, 30 equals 1/30 sec.)
- 2 The yellow B represents BULB. When the Shutter Speed Dial is set to B, the Shutter remains open as long as the Shutter Release Button is depressed.
- 3 The red 60 (1/60 sec) represents the highest permissible shutter speed for electronic flash synchronization.
- 4 The red ● mark is the AE position, and ■ is the AE Lock position. These marks are used with the AE Prism Finder N. (When the Prism Finder N and Waist Level Finder N are attached, and the dial is set at ● or ■, the effective shutter speed is 1/1000 sec).
- 5 Set the Shutter Speed Dial only to the click stop position. Using an intermediate positions will result in inaccurate exposure.

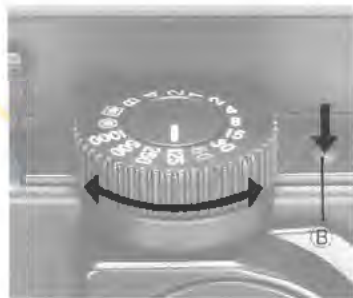

When selecting shutter speed settings other than the ● and ■ marks, release the lock by pushing the button (B) in front of the dial. Turn the Shutter Speed Dial to your desired speed.



- 1 While looking through the viewfinder, adjust the lens Focusing Ring until the most important part of the subject appears sharp and clear.
- 2 Extremely accurate focusing is simplified by the split-image rangefinder spot located in the center of the Focusing Screen. (to use, match up the image on both sides of the split-image.)



3. The split-image rangefinder spot is surrounded by a microprism collar which fractures the image whenever it goes slightly out-of-focus. Consequently, this is an invaluable aid for pinpoint focusing accuracy.
4. The outer ground glass ring (which encircles the microprism collar) can be also used for focusing.

*As an accessory, Mamiya offers Diopter Correction Lenses which can be attached to the viewfinders. Near and farsighted persons will find these accessories useful for obtaining accurate focus.

*The Focusing Screen is interchangeable. To change screens, refer to the instruction manual supplied with the screens.

APERTURE RING/STOP-DOWN OPERATION



Set the desired f/stop on the Aperture Ring (A) by aligning the f/number with the red reference dot (B). (The Aperture Ring has a click stop for each f/stop. In-between clicks can also be used.)

AM (Auto/Manual) Lever

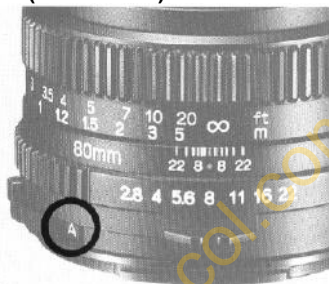

1. In normal photography, set AM Lever so that character "A" is visible in the lever window. If you do so, the aperture will remain wide open, stopping the lens down only during shutter operation.
2. Moving the AM Lever of the lens so that "M" is visible will stop the lens down to the preselected aperture, thus making it possible to confirm effect of the aperture through the viewfinder.

SHUTTER RELEASE BUTTON OPERATION

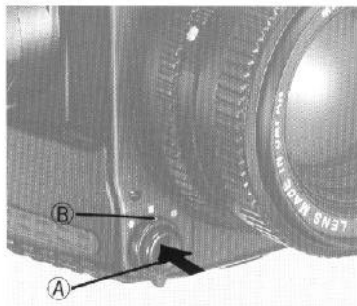

1. The Shutter Release Button (A) is a 2-step type. The release pressure will charge halfway through the cycle. The first step light up the metering related display. The second step is the electromagnetic shutter release position. (The first position operates only when the AE Prism Finder N is used.)

2. If the film is not completely advanced, the Dark Slide is not removed or the battery is exhausted, the shutter can not be released even when pushing the Shutter Release Button.
3. After releasing the shutter, the Wind-up Crank is unlocked automatically, making it possible to transport the film to the next frame.

*In normal photography, set the shutter Release Selector (B) to the "NORMAL" (white square) position.

*Note: Always make sure that the Shutter Release Selector clicks into position. When the battery is exhausted during photography, and the shutter can not be released, set the selector to the yellow dot, and you will be able to use the mechanical shutter at 1/60 sec.

When this setting is used, the shutter speed is always 1/60 sec. regardless of the Shutter Speed Dial position. When your camera is not in use, set the Shutter Release Selector to the red dot so that the power is turned OFF.

Eye-level Operation



No matter how carefully one focuses the camera, if there is camera movement during the instant that the shutter is released, sharp pictures are unlikely. To eliminate camera movement, care must be taken regarding the method of holding the camera and releasing the shutter.

Waist-level Operation



When hand-holding the camera with the Waist Level Finder attached, adjust the length of the neck strap to take out the slack and support the camera firmly against your body.

Attaching it to the camera

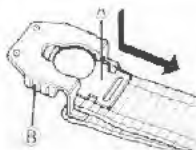

1. Draw out the neck strap fastener (A) of the attaching clip while pushing it down.



2. Place the hole of the strap fastener (A) over the lifting lug of camera body as illustrated, and pull until it clicks and locks into place.

Removing it from the camera

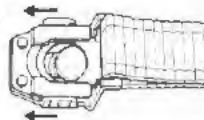

With your finger, pull the neck strap fastener (A) of attaching clip upward and push part (B) in the direction of the arrow. The strap can now be removed.

When attaching the strap to the lifting lug on the side of the camera with the Wind-up Crank, insert the neck strap fastener (A) into the lower pad of the double slot.

FILM TRANSPORT AND UNLOADING OF EXPOSED FILM

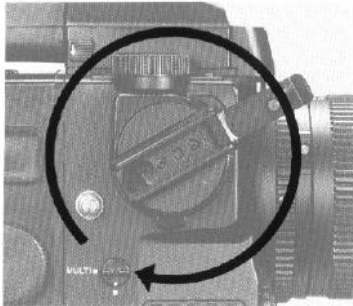

1. Turn the Wind-up Crank until it stops (one turn), and the camera is ready for the next exposure.
2. After the fixed number of exposures has been taken (15 for 120 film, 30 for 220 film), the Shutter Release Button automatically locks, and the Wind-up Crank becomes free. At that time, wind the Crank until the leader paper is completely wound onto the Take-up Spool. (By turning the crank 4 to 5 times after the final frame of the film comes in sight, the film will be wound up completely.)

3. Open the Back Cover, and remove the Roll Film Insert. The exposure counter will return to S (start) automatically.
4. Move the Spool Clip of the Roll Film Insert outward to remove the film.
5. Remove the film from the Roll Film Insert, exercising care that the film does not loosen, and seal it.

Depth-of-field refers to the total area (foreground and background) which will appear in sharp focus. The area of sharpness (depth-of-field) depends upon the distance the lens is focused at, the f/stop (or aperture) being used, and the focal length of the lens.

The area that will appear sharp can be determined as follows:

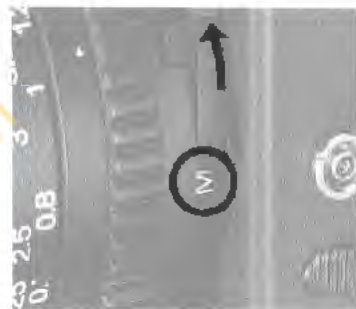

1. Depth-of-field can be determined by referring to the Depth-of-field Scale engraved on the lens.
For example, with the 60mm f/2.8N lens focused at 10ft. (3m) and the Aperture Ring set to f/22, the Depth-of-field Scale reveals that everything from about 7ft. (2m) to about 20 ft. (6m) will appear sharp.

2. The lens can also be stopped down to the preselected aperture for direct viewing of the depth-of-field by using the AM Lever on the lens.
To do so, move the lever so that "M" (manual) is visible. When the lens is set to "M" you can take a picture observing the depth-of-field in the finder.

Depth-of-Field Scale

o Mamiya-Sekor C 80mm f/2.8N

Aperture	Distance (meter)										
	∞	10	5	3	2	1.5	1.2	1	0.9	0.8	0.7
2.8	∞	12.76	5.59	3.20	2.08	1.54	1.23	1.02	0.91	0.81	0.71
	45.39	8.23	4.52	2.83	1.92	1.46	1.17	0.98	0.89	0.79	0.69
4	∞	14.40	5.88	3.29	2.12	1.56	1.24	1.02	0.92	0.81	0.71
	32.12	7.67	4.35	2.76	1.90	1.44	1.16	0.98	0.88	0.79	0.69
5.6	∞	17.63	6.34	3.42	2.17	1.59	1.25	1.04	0.93	0.82	0.71
	22.73	6.99	4.13	2.67	1.86	1.42	1.15	0.97	0.87	0.78	0.69
8	∞	25.83	7.14	3.63	2.25	1.63	1.28	1.05	0.94	0.83	0.72
	16.09	6.22	3.86	2.56	1.80	1.39	1.13	0.95	0.86	0.77	0.68
11	∞	75.89	8.68	3.98	2.37	1.69	1.31	1.07	0.96	0.84	0.73
	11.40	5.38	3.52	2.41	1.73	1.35	1.11	0.94	0.85	0.76	0.67
16	∞	∞	12.54	4.61	2.58	1.79	1.37	1.11	0.98	0.86	0.74
	8.08	4.53	3.14	2.23	1.64	1.30	1.07	0.91	0.83	0.75	0.66
22	∞	∞	34.15	5.95	2.93	1.94	1.45	1.16	1.02	0.89	0.76
	5.74	3.70	2.73	2.02	1.53	1.23	1.03	0.88	0.81	0.73	0.65



★ Precaution when Using Flash

When using the Hot-shoe, be sure to insert the appropriate safety cover into the X-sync terminal. This procedure will prevent the possibility of receiving an electric shock while an electronic flash is attached if the terminal not being used is accidentally touched.

The bracket of a handle-mount flash unit can be attached to the camera's tripod socket. A shoe-mount flash can be attached to the camera's Hot-shoe or the Hot-shoe of the Left Hand Grip.

*The Mamiya M645 Super has an X-sync terminal.

- (1) When using an electronic flash, plug the synchronization cord into the sync terminal and set the Shutter Speed Dial to 1/60 sec. or longer.

- (2) For MF and M bulbs, set the Shutter Speed Dial to 1/30 sec. or longer for MF-type bulbs; 1/15 sec. or longer for M-type bulbs.

- ★ If the flash duration of an electronic flash is longer than 1/1000 sec., set the Shutter Speed Dial to 1/30 sec. or longer.
- ★ When using flash, carefully read the instructions packed with the flash bulbs or flash unit to avoid making errors.

Flash Synchronization Chart

Sync Terminal	Shutter Speeds												
	1/1000	1/500	1/250	1/125	1/60	1/30	1/15	1/8	1/4	1/2	1	2	4
X	Electronic flash												
	MF Class												
	M Class												

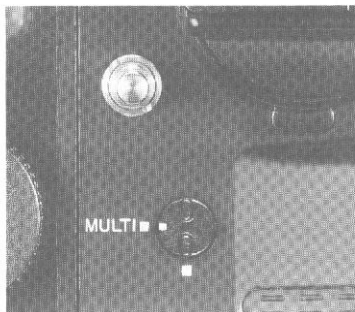

When the Multiple Exposure Lever is aligned with "MULTI", the double-exposure prevention mechanism is disengaged, so that the shutter can be cocked (and even with the Wind-up Crank turned) without moving the film, making multiple exposures possible on the same frame.

(When making multiple exposures, the exposure counter will not advance.)

*Remember to return the lever to the white square mark position upon completion of the multiple exposure. If you forget to return the lever, multiple exposures will continue to occur on and the next frame.



When using infrared film, it is necessary to make a focusing adjustment in order to achieve accurate focus. This is because the focus position of the image deviates from normal since the infrared ray wavelength is longer.

Focusing Adjustment Procedure:

1. The red dot or line on the right side of the lens center reference line is the infrared mark.
2. After focusing in the usual manner, check the distance on the Distance Scale that is aligned with the center

reference mark of the lens. Make the focusing adjustment by turning the Focusing Ring slightly in the direction of the arrow in the accompanying photograph so that the distance just observed is aligned with the infrared mark. Focus is now correct for infrared and you can release the shutter.

*For information regarding the proper filter and exposure, refer to the data sheet packed with the film. Always use the appropriate filter for the lens.

To take time exposures, set the Shutter Speed Dial to "B" and use a cable release with a lock provision. Inserting an optional Cable Release Adapter into the Auxiliary Release Contact of camera body, allows a cable release to be used.



When the camera is mounted on a tripod for copy work, close-ups or telephotography at long (slow) shutter speeds, the small amount of vibration due to "mirror-bounce", which is normally of no consequence, may cause blurring of the image due to the high magnification encountered in extreme close-ups and telephotography. Mirror shock can be eliminated by locking the mirror in the up position before making the exposure.

1. To lock the mirror up, move the Mirror Lock-up Lever to "M. UP" until it clicks.
2. With this setting, the mirror is locked up. Naturally, no image can be seen on the screen through the viewfinder. Consequently, when adjustments for composition and focusing are required return the mirror to its normal position. (lower the mirror).

*When using the 70mm Leaf Shutter Lens, be sure to refer to the instructions packed with the lens.

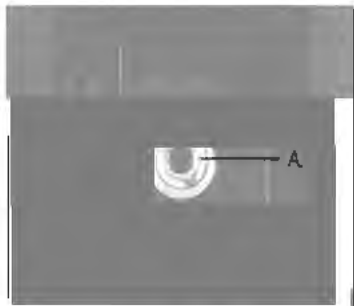

To attach to tripods with a 3/8" screw unscrew the small screw found in the base of the camera's tripod socket using a regular screwdriver (-).

Next, remove the adapter (A) by inserting a coin in the slot.

Finally, attach the camera to the 3/8" tripod.

When attached to the accessory Revolving Tripod Adapter, the Mamiya M645 Super can be instantly rotated to change from vertical to horizontal format, or vice versa.

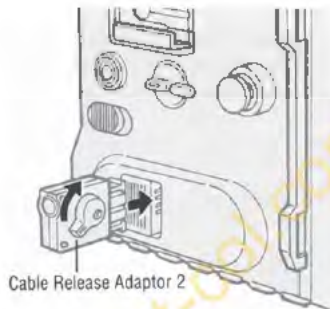

Cable Release Adaptor 2

In order to have the capability of delayed shutter release, you must first insert an optional Cable Release Adaptor 2 into the camera's Auxiliary Release Contact, and any commercially available self-timer cable release can be used.

This section will be very useful for you. In case of any difficulties in operation, please read the following points.

1. The Shutter Release Button will not Move.

- (a) Check that the Shutter Release Selector is not in the locked position (Red dot).
- (b) Check that the Wind-up Crank has been wound until it stops.
- (c) Check that the Battery Check Lamp will light. (If not, replace the battery.)
- (d) Check that the Dark Slide of the Roll Film Holder has been removed.

2. The Mirror is locked in the Up Position. (Nothing can be seen through the finder.)

- (a) Check that the Mirror Lock-up Lever is not in the "M. UP" position. (Set the Multiple Exposure Lever to white mark)
- (b) Check that the Battery Check Lamp lights. (If not, rapidly turn the Shutter Release Selector to the yellow dot so that the Shutter Curtain will be closed and the mirror will return.) Replace the battery.

3. Though the fixed Number of Exposure has been Taken.

The Developed Roll Film has Fewer Exposures than it should have.

- (a) Check that start mark of film has been aligned correctly.

4. The Roll Film Holder cannot be Removed.

- (a) Check that the Dark Slide has been inserted.

5. Precautions for Mirror Lock-up Lever

If you carry a camera with you outdoors with the Mirror Lock-up Lever at "M. UP", light passing through the lens will hit the Shutter Curtain, thereby possibly causing damage to the curtain. If there is a time lapse before the next shot during mirror lock-up photography, return the lever to "NORMAL" or put a cap on the lens.

6. Precautions for Photographic at Low temperatures

- (a) Be sure to use a new battery.
- (b) When using a flash, set the Shutter Speed Dial to 1/30 sec. or longer.
- (c) Place the camera in the outside air only during the moment of exposure.

A battery that can not be used at low temperatures will sometimes become usable again when it is returned to normal temperature. However, the battery should not be subjected to rapid and extreme changes of temperature, or the battery life will be shortened.

7. Precautions for AE Shooting

- (a) Set the film holder's Film Speed Dial to the sensitivity of the film to be used.

STORING AND CHECKING THE CAMERA

When the camera is not used for a long period of time, remove the battery and any film from the camera.

Avoid storing the camera for prolonged periods of time in a damp or salty atmosphere. (Color film should be stored at the manufacturer's recommended temperatures.)

Since cameras are precision instruments, avoid shocks and rough handling.

When the camera is stored for a long time, periodically remove the camera and release the shutter several times to keep the camera in good condition.

Cleaning:

Never touch the lens or mirror surfaces. When your camera is contaminated with dust, fingerprints and so on, blow away the dust particles with a blower, and clean the lens surface with lens cleaning tissue and lens cleaner. Merely blowing dust particles off the mirror surface is sufficient—never touch the mirror.

Periodic Check:

Periodically check the camera to make sure that it is in working order. This is especially important before a photographic assignment. (Check the battery, flash synchronization, mirror and shutter movement, film wind, diaphragm automation and so on.)

If the camera is malfunctioning, take it to the nearest authorized Mamiya Service Center for repairs.

Camera type	: 6 x 4.5cm electronic focal-plane shutter SLR
Actual negative size	: 56 x 41.5mm
Film type	: 120 roll film (15 exposures) 220 roll film (30 exposures) Polaroid® Land Pack film (Polaroid 100, 600 series) 135 roll film in film cartridge
Film loading	: Daylight loading interchangeable film backs with film speed dial available for each film type.
Standard lenses	: Mamiya-Sekor C 80mm f/2.8N (Multicoated) Mamiya-Sekor C 80mm f/1.9 (Multicoated)
Lens mount	: M645 bayonet mount (applicable to all M645 lenses)
Shutter	: Moving coil, quartz-controlled focal-plane shutter
Shutter speed	: (Electronic) B.4-1/1000 sec. (Mechanical) 1/60 sec.
Shutter release	: Electromagnetic release. Built-in shutter release lock and manual lock provided.
Mirror	: Instant return reflective mirror, with mirror lock-up capability.
Viewfinder	: Interchangeable (Waist Level Finder N, Prism Finder N and AE Prism Finder N)
Focusing screen	: Standard: Rangefinder Spot/Microprism. with Fresnel lens, accessory screens available.

Field of view	94%
Film Transport	Single turn winding by Wind-up Crank. Variable crank start position (6 positions). Power Drive
Exposure counter	Progressive type, automatic reset. The counter for 120 and 220 film will be automatic.
Multiple exposure	Available with Multiple Exposure Lever.
Depth-of-field	Depth-of-field Scale provided on lens
Auxiliary release contact	With Receiver MZ inserted into body Contact, Transmitter MZ can be used for remote control. With Cable Release Adapter in the contact, cable release and self-timer cable can be used.
Battery checker	Red LED lights up. With Battery Check Button.
Synchronization	X terminal (hot shoe/terminal), Flash synchronization at 1/60 sec. or slower speeds
Back cover	Dark Slide Storage, Memo Clip
Power supply	6V battery x 1 (4SR44 silver-oxide battery of 4LR44 alkaline-manganese battery)
Others	With neck strap.
Size & Weight	Body with 120 Roll Film Holder/ 3.6"(W) x 3.4"(H) x 4.6"(D) 31.3 oz. 91 (W) x 87.5(H) x 116(D) mm 895g